



ANORA
— Lighting —



MODEL NO.: BI-1131

Features:

- Three color temperature
- Side panel lighting
- Soft light
- Anti glare
- Touch stepless dimming
- Delayed light off function



Light Body Color: Metallic Grey

Description:

Power: 10W

Voltage: AC100-240V, DC12V

Colour Temp: 3000K-4000K-6000K

Lumen: 480 Max

CRI: ≥90Ra

Wireless charging is optional - BI-1131C

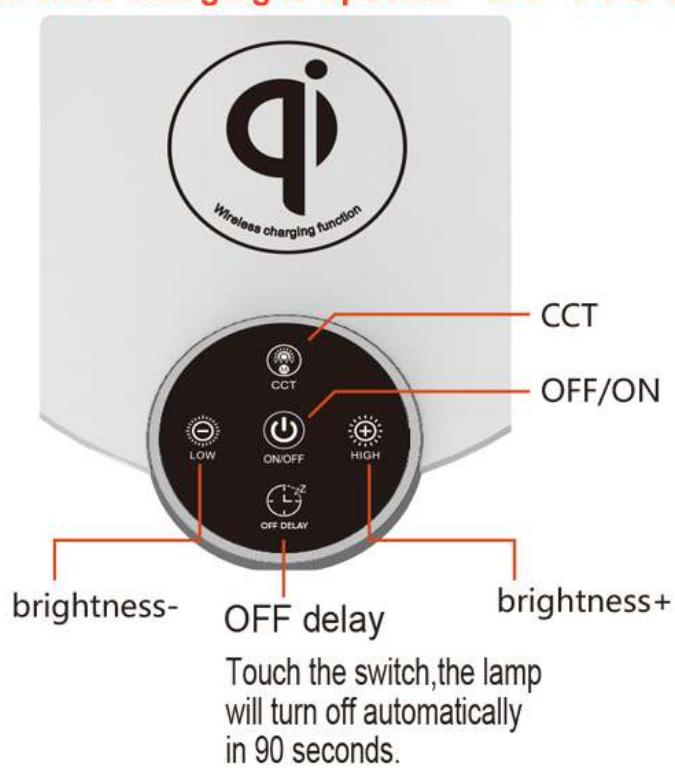

Light Body Color: Matt White

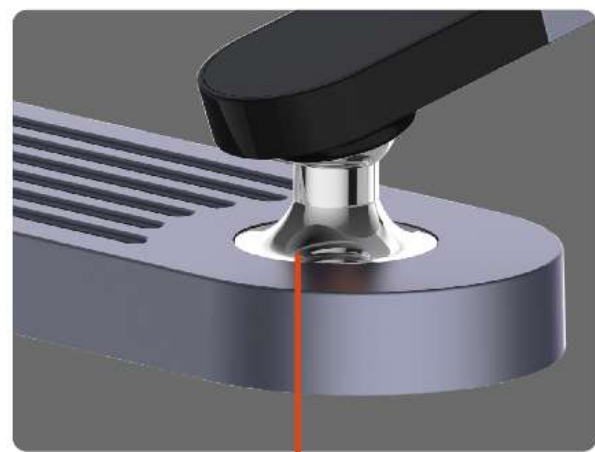
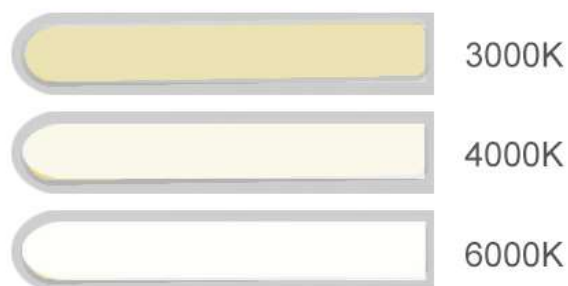

Electroplated joint, multi angle rotation.

Multi angle rotation, folding design, small package.

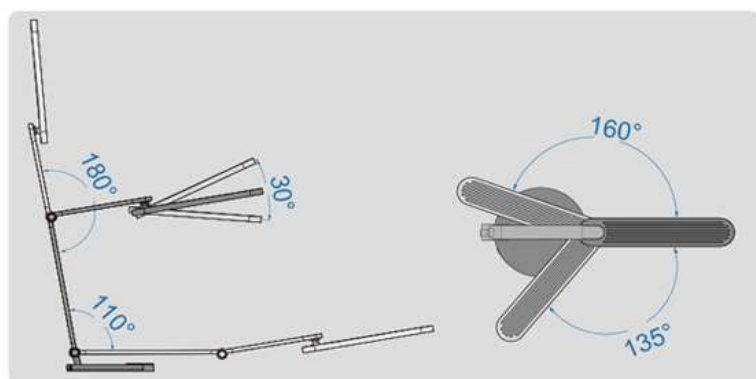

Light Body Color: Matt Black

Note: If the product color changes, the actual color will be as produced at that time.

MODEL NO.: BI-1153

Features:

- Multi-functional LED table lamp
- Three color temperature
- Side panel lighting
- Double dimming function
- Soft light
- Anti glare

Description:

Power: 10W

Voltage: AC100-240V, DC12V

Colour Temp: 3000K-4000K-6000K

Lumen: 530 Max

CRI: ≥90Ra

- White
- Blue
- Black



lampshade is optional - **BI-1152**



Double Dimming Mode

- Slightly press to adjust brightness in three steps.
- Long press to stepless adjust brightness(10%-100%) .



- White
- Blue
- Black

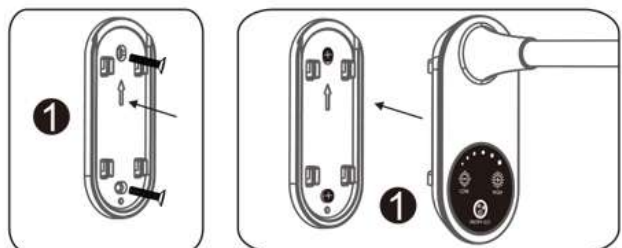

1. Take out the hanging plate, remove the protective film from adhesive tape, paste the hanging plate to the wall in ideal position.

*Take out the hanging plate, fix the plate to wall in ideal position with attached screws.

Notice: Hang plate shall be pasted to rigid and smooth wall, uneven wall is not allowed.

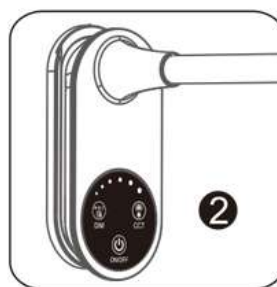

2. Insert the lamp into the panel according to the direction of the clasp and pull it down to check whether it is fixed or not.

Note: If the product color changes, the actual color will be as produced at that time.

MODEL NO.: BI-1161

Features:

- Multi-functional LED table lamp
- Three color temperature
- Side panel lighting
- Double dimming function
- Soft light
- Anti glare
- LED night light

Description:

Power: 10W

Voltage: AC100-240V, DC12V

Colour Temp: 3000K-4000K-6000K

Lumen: 530 Max

CRI: ≥90Ra



Light Body Color: Black



Light Body Color: White



Light Body Color: Blue

With night light

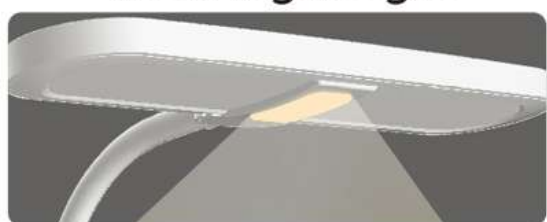

Double Dimming Mode

- Slightly press to adjust brightness in three steps.
- Long press to stepless adjust brightness(10%-100%) .

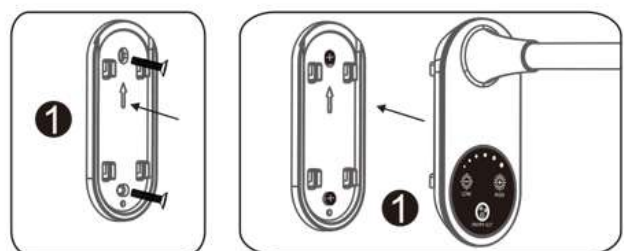

1. Take out the hanging plate, remove the protective film from adhesive tage, paste the hanging plate to the wall in ideal position.

*Take out the hanging plate, fix the plate to wall in ideal position with attached screws.

Notice: Hang plate shall be pasted to rigid and smooth wall, uneven wall is not allowed.



2. Insert the lamp into the panel according to the direction of the clasp and pull it down to check whether it is fixed or not.

Note: If the product color changes, the actual color will be as produced at that time.

MODEL NO.: BI-1167

Features:

- Delayed light off function
- Rest reminder for reading
- Three color temperature
- Rotating stepless dimming
- Side panel lighting
- Anti glare
- Soft light

Description:

Power: 12W

Voltage: AC100-240V, DC12V

Colour Temp: 3000K-4000K-6000K

Lumen: 560 Max

CRI: ≥90Ra



Light Body Color: Metallic Grey



Metallic rotary knob
rotating stepless dimming



OFF delay

- Touch the switch, the light will turn off automatically after 90 seconds



Rest reminder for reading

- Short press to set rest reminder, works in 30 mins
- Long press to test reminder function, lamp will flash in 5 seconds.

Three color temperature,
Side panel lighting, **Soft light**, Anti glare



Light Body Color: Brushed silver

Note: If the product color changes, the actual color will be as produced at that time.

MODEL NO.: BI-1167P

Features:

- Delayed light off function
- Rest reminder for reading
- Three color temperature
- Rotating stepless dimming
- Side panel lighting
- Anti glare
- Soft light

Description:

Power: 12W

Voltage: AC100-240V, DC12V

Colour Temp: 3000K-4000K-6000K

Lumen: 560 Max

CRI: ≥90Ra

- Long press the color temperature and on/off key at the same time to turn on/off the display backlight.



Light Body Color: Metallic Grey



Multi angle rotation

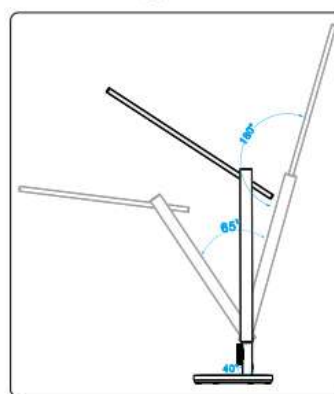

M Time setting

- Short press "M" to switch 12/24 hour type. Sign of AM in 12 hour mode.
- Long press "M" to enter the switch adjustment position, the hour logo flashes (flash interval 500ms), the hour digit value can be increased or decreased by rotating the dimming knob (clockwise/counterclockwise); Press this button again to switch to the minute digit flashing remind (flashing interval 500ms), to increase or decrease the minute value through rotating the dimming knob clockwise/counterclockwise; Press this button again to save and exit the time setting mode.

⏻ ON/OFF Mode

- Short touch to turn on/off lamp. (It remain last CCT & brightness when turn on again)

☀️ CCT mode

- Press the main lighting CCT to switch among natural light 3800K, warm light 3000K and day light 5700K. At any CCT, you can rotate the "knob" to increase or decrease the brightness of the light steplessly.

Three color temperature, Side panel lighting, **Soft light**, Anti glare



Lampbody seperated design, small package

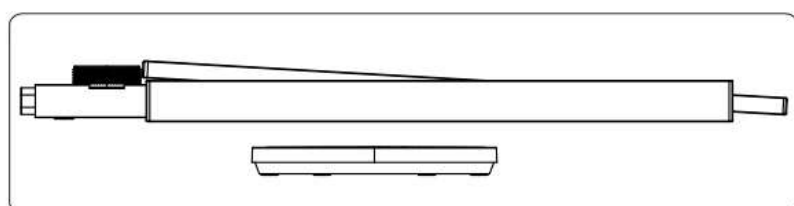

Light Body Color: Brushed silver

Note: If the product color changes, the actual color will be as produced at that time.

MODEL NO.: BI-1268

Features:

- Three color temperature
- Side panel lighting
- Rotating stepless dimming
- Delayed light off function
- Soft light
- Anti glare
- Multi-functional LED table lamp

Description:

Power: 10W

Voltage: AC100-240V, DC12V

Colour Temp: 3000K-4000K-6000K

Lumen: 480 Max

CRI: ≥90Ra



Sliver Metallic Grey

Wireless charging is optional - **BI-1268C**



Rotating stepless dimming



MODEL NO.: BI-1239

Features:

- Delayed light off function
- Rest reminder for reading
- Three color temperature
- Rotating stepless dimming
- Side panel lighting
- Soft light
- Anti glare

Description:

Power: 12W

Voltage: AC100-240V, DC12V

Colour Temp: 3000K-4000K-6000K

Lumen: 600 Max

CRI: ≥90Ra

LED Illuminated touch buttons



Rotating Stepless dimming

USB charging 5V/2A

White Black Metallic Grey



USB charging is optional - **BI-1239U**

Note: If the product color changes, the actual color will be as produced at that time.

MODEL NO.: BI-1304

Features:

- LCD display of time
- Digital display of delay off function
- Three color temperature
- Anti-glare stereoscopic light source
- Double dimming function
- Soft light
- With pen holder

Description:

Power: 12W
 Voltage: AC100-240V, DC12V
 Colour Temp: 3000K-4000K-6000K
 Lumen: 610 Max
 CRI: ≥90Ra



Transparent optical mirror lampshade



Lampshade can be rotated in 180°

MODEL NO.: BI-1304T

Features:

- LCD display of time
- Digital display of delay off function
- Three color temperature
- Anti-glare stereoscopic light source
- Double dimming function
- Soft light
- With pen holder

Description:

Power: 12W
 Voltage: AC100-240V, DC12V
 Colour Temp: 3000K-4000K-6000K
 Lumen: 610 Max
 CRI: ≥90Ra

Transparent optical mirror lampshade



With night light

Lampshade can be rotated in 180°

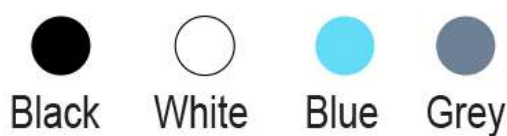

pen holder

LCD display of time



pen holder

LCD display of time

Note: If the product color changes, the actual color will be as produced at that time.

MODEL NO.: BI-1304N

Features:

- Three color temperature
- Anti-glare stereoscopic light source
- Touch stepless dimming
- LED night light
- Soft light
- Multi-functional LED table lamp
- With pen holder

Description:

Power: 12W
 Voltage: AC100-240V, DC12V
 Colour Temp: 3000K-4000K-6000K
 Lumen: 610 Max
 CRI: ≥90Ra



- Black
- White
- Blue
- Grey

MODEL NO.: BI-1305

Features:

- Display of rest reminder countdown and brightness value
- LCD display of time
- Rotating stepless dimming
- Side emitting
- Anti glare
- Soft light
- With pen holder

Description:

Power: 12W
 Voltage: AC100-240V, DC12V
 Colour Temp: 3000K-4000K-6000K
 Lumen: 610 Max
 CRI: ≥90Ra



pen holder

With night light

- NL ON/OFF
• NL Brightness
- CCT
• DIM
- ON/OFF

LCD display of time



- Illuminated Brightness Strips
- Brightness value
- Rest reminder countdown

Rotating Stepless dimming

- CCT
- Rest reminder
- ON/OFF
- Time setting

- White
- Blue
- Grey



Note: If the product color changes, the actual color will be as produced at that time.

MODEL NO.: BI-1311T

Features:

- LCD display of time
- Digital display of delay off function
- Three color temperature
- Anti glare
- Soft light
- Double dimming function
- With pen holder

Description:

Power: 12W
 Voltage: AC100-240V, DC12V
 Colour Temp: 3000K-4000K-6000K
 Lumen: 530 Max
 CRI: ≥90Ra



○ White ● Blue

MODEL NO.: BI-1311

Features:

- LCD display of time
- Digital display of delay off function
- Three color temperature
- Double dimming function
- Transparent optical mirror lamp shade
- Anti glare & Soft light
- With pen holder

Description:

Power: 12W
 Voltage: AC100-240V, DC12V
 Colour Temp: 3000K-4000K-6000K
 Lumen: 530 Max
 CRI: ≥90Ra



pen holder
 LCD display of time



Transparent optical mirror lampshade



pen holder
 LCD display of time



○ White ● Blue

Note: If the product color changes, the actual color will be as produced at that time.

MODEL NO.: BI-1321

Features:

- LCD display of time
- Three color temperature
- Side panel lighting
- Double dimming function
- Delayed light off function
- Anti glare
- Soft light

Description:

Power: 12W

Voltage: AC100-240V, DC12V

Colour Temp: 3000K-4000K-6000K

Lumen: 700 Max

CRI: ≥90Ra



BI-1321D



Multi-purpose lamp clamp

both desk lamp & clip lamp is available



MODEL NO.: BI-1821D

Features:

- LCD display of time
- Three color temperature
- Side panel lighting
- Double dimming function
- Delayed light off function
- Anti glare
- Soft light

Description:

Power: 12W

Voltage: AC100-240V, DC12V

Colour Temp: 3000K-4000K-6000K

Lumen: 700 Max

CRI: ≥90Ra



BI-1821

Both desk lamp & clip lamp is available



Note: If the product color changes, the actual color will be as produced at that time.

MODEL NO.: BI-1525A

Features:

- Three color temperature
- Anti-glare stereoscopic light source
- Touch stepless dimming
- With pen holder
- Mobile phone holder
- LED night light
- Anti-glare stereoscopic light source

Description:

Power: 10W

Voltage: AC100-240V, DC12V

Colour Temp: 3000K-4000K-6000K

Lumen: 530 Max

CRI: ≥90Ra



pen holder

luminous mobile phone holder
Dimmable LED night light

- ON/OFF Mode
ON/OFF
- Short press to adjust CCT
 • Long press for stepless dimming
▲ CCT
▼ DIM
- Short press for night light on/off
 • Long press for night light dimming
▲ NL ON/OFF
▼ NL Brightness

MODEL NO.: BI-1515A

Features:

- Three color temperature
- Anti-glare stereoscopic light source
- Touch stepless dimming
- With pen holder
- Mobile phone holder
- LED night light
- Anti-glare stereoscopic light source

Description:

Power: 10W

Voltage: AC100-240V, DC12V

Colour Temp: 3000K-4000K-6000K

Lumen: 530 Max

CRI: ≥90Ra



Note: If the product color changes, the actual color will be as produced at that time.

MODEL NO.: BI-1624

Features:

- LCD display of time
- Digital display of delay off function
- Three color temperature
- Anti-glare stereoscopic light source
- Double dimming function
- With night light
- Anti glare

Description:

Power: 12W

Voltage: AC100-240V, DC12V

Colour Temp: 3000K-4000K-6000K

Lumen: 610 Max

CRI: ≥90Ra

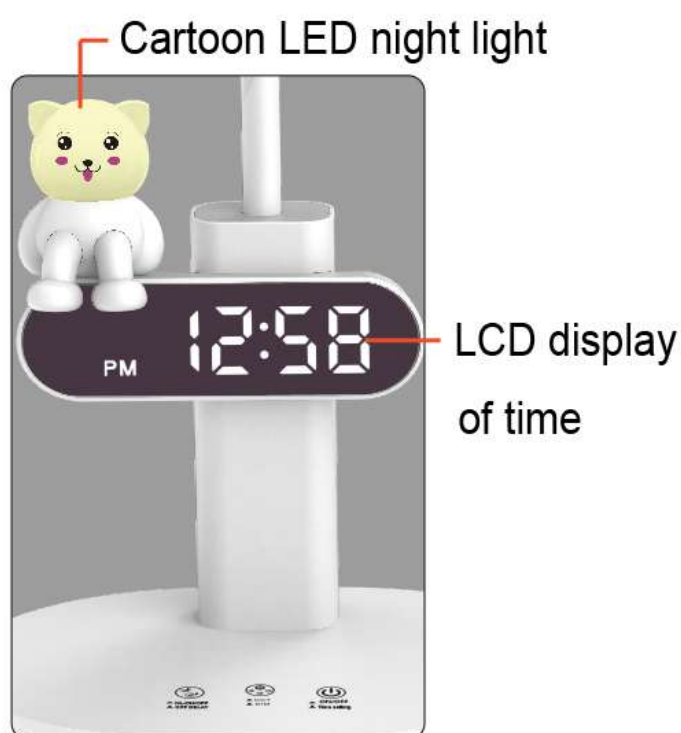

MODEL NO.: BI-1632

Features:

- Three color temperature
- Anti-glare stereoscopic light source
- Touch stepless dimming
- With pen holder
- LED night light
- Delayed light off function

Description:

Power: 12W

Voltage: AC100-240V, DC12V

Colour Temp: 3000K-4000K-6000K

Lumen: 600 Max

CRI: ≥90Ra

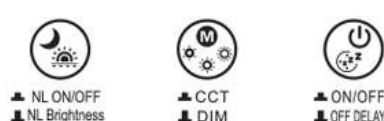
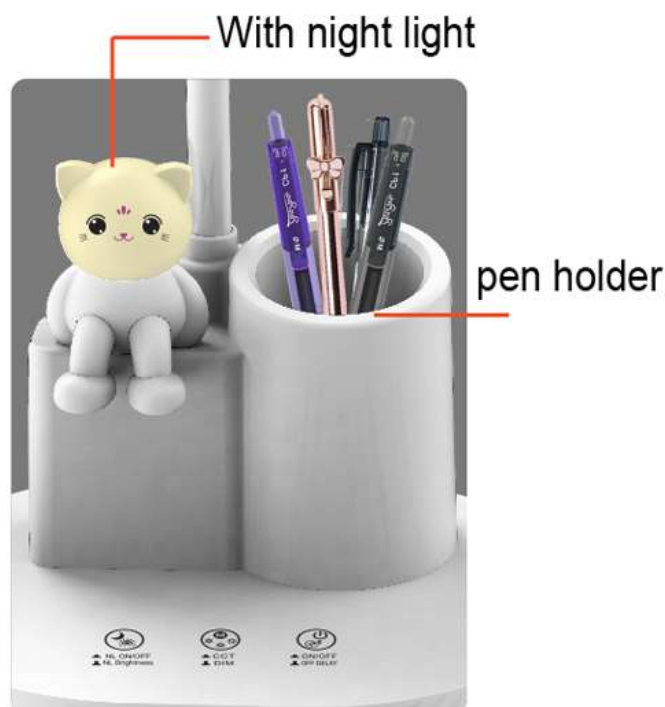

Note: If the product color changes, the actual color will be as produced at that time.

MODEL NO.: BI-1841T

Features:

- Display of rest reminder countdown and brightness value
- LCD display of time
- Rotating stepless dimming
- Side emitting
- Soft light
- Anti glare

Description:

Power: 12W
 Voltage: AC100-240V, DC12V
 Colour Temp: 3000K-4000K-6000K
 Lumen: 650 Max
 CRI: ≥90Ra

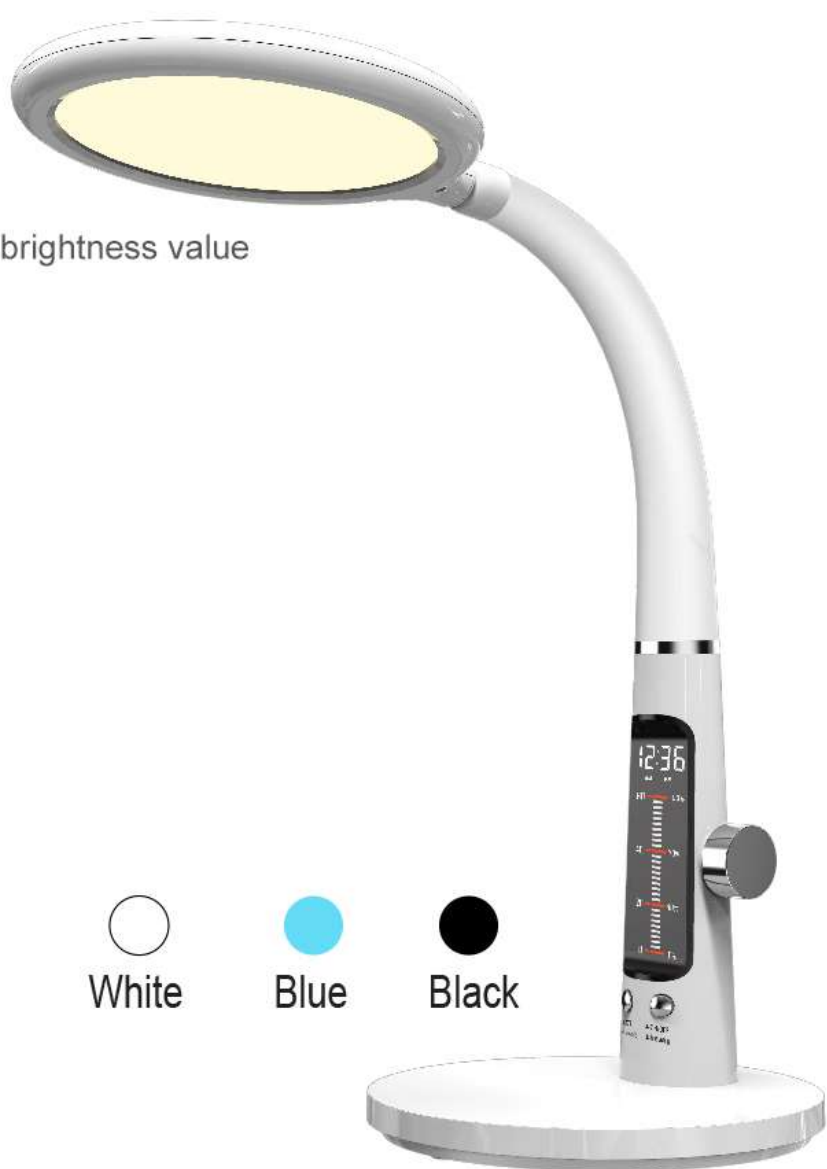

 White
  Blue
  Black

LCD display of time, rest reminder countdown and brightness value.

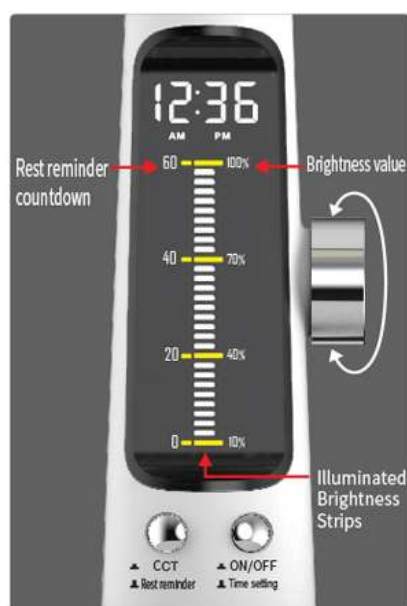

Metallic rotary knob
 Rotating Stepless dimming

- **ON/OFF / Time setting**
- Short press to on/off
- Long press to set time



Lampshade can be rotated in 180°

MODEL NO.: BI-1841

Features:

- Three color temperature
- Side panel lighting
- Side emitting
- With LED indicator light
- Soft light
- Anti glare

Description:

Power: 12W
 Voltage: AC100-240V, DC12V
 Colour Temp: 3000K-4000K-6000K
 Lumen: 650 Max
 CRI: ≥90Ra



Blue indicator light follow the finger moving



 White
  Blue
  Black

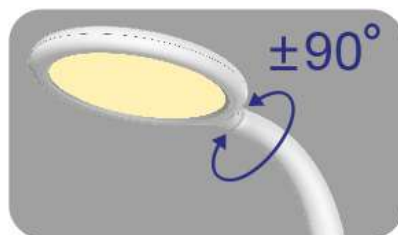

Lampshade can be rotated in 180°

Note: If the product color changes, the actual color will be as produced at that time.

MODEL NO.: BI-1892

Features:

- Delayed light off function
- Rest reminder for reading
- Three color temperature
- Rotating stepless dimming
- Side panel lighting
- Anti glare
- Soft light

Description:

Power: 12W

Voltage: AC100-240V, DC12V

Colour Temp: 3000K-4000K-6000K

Lumen: 620 Max

CRI: ≥90Ra



Brushed Silver

Metallic rotary knob

Rotating Stepless dimming



Metallic Grey

OFF delay

- Touch the switch, the light will turn off automatically after 90 seconds

Rest reminder for reading

- Short press to set rest reminder, works in 30 mins
- Long press to test reminder function, lamp will flash in 5 seconds.

Three color temperature, Side panel lighting, **Soft light**, Anti glare

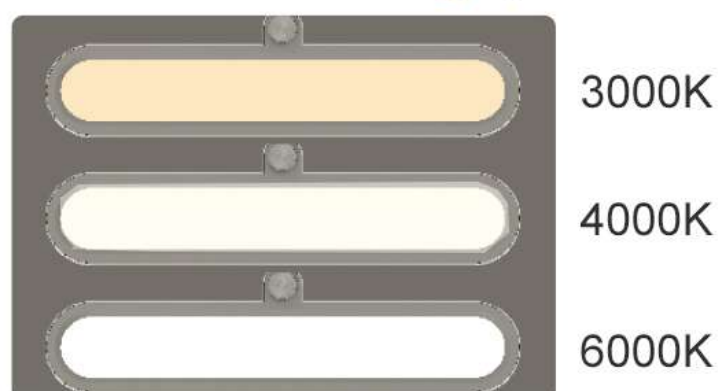

Multi angle rotation

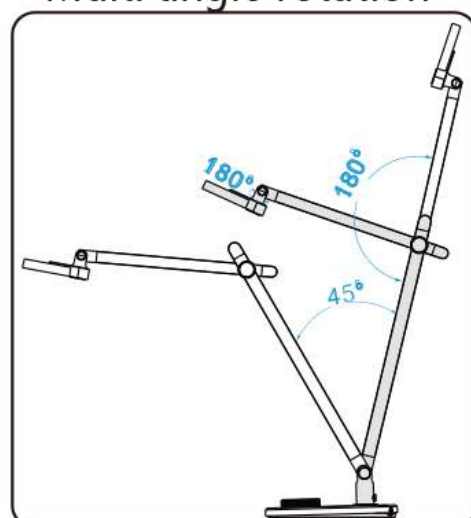

Note: If the product color changes, the actual color will be as produced at that time.

MODEL NO.: BI-1892T

Features:

- Delayed light off function
- Three color temperature setting
- Rotating stepless dimming
- Anti glare
- Soft light

Description:

Power: 12W
 Voltage: AC100-240V, DC12V
 Colour Temp: 3000K-4000K-6000K
 Lumen: 620 Max
 CRI: ≥90Ra



● Brushed Silver ● Metallic Grey

Long press the color temperature and on/off key at the same time to turn on/off the display backlight.



Metalic rotary knob
 Rotating Stepless dimming

Three color temperature, Side panel lighting, **Soft light**, Anti glare

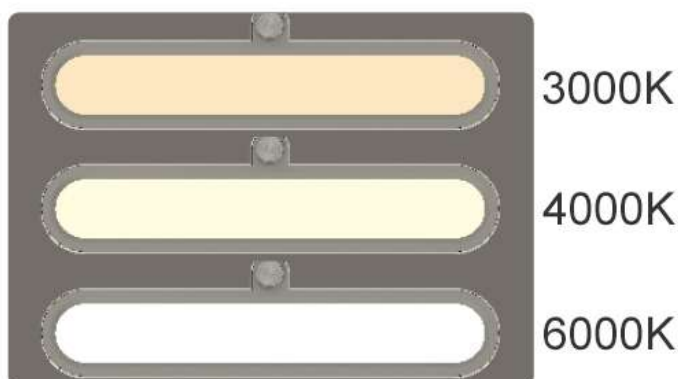

Multi angle rotation

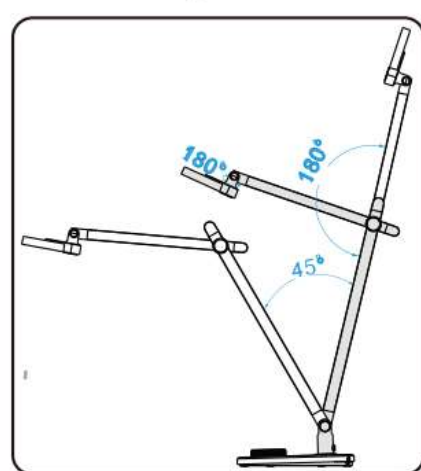

(M) Time setting

- Short press "(M)" to switch 12/24 hour type. Sign of AM in 12 hour mode.
- Long press "M" to enter the switch adjustment position, the hour logo flashes (flash interval 500ms), the hour digit value can be increased or decreased by rotating the dimming knob (clockwise/counterclockwise); Press this button again to switch to the minute digit flashing remind (flashing interval 500ms), to increase or decrease the minute value through rotating the dimming knob clockwise/counterclockwise; Press this button again to save and exit the time setting mode.

(Power) ON/OFF Mode

- Short touch to turn on/off lamp. (It remain last CCT & brightness when turn on again)

(Sun) CCT mode

- Press the main lighting CCT to switch among natural light 3800K, warm light 3000K and day light 5700K. At any CCT, you can rotate the "knob" to increase or decrease the brightness of the light steplessly.

Note: If the product color changes, the actual color will be as produced at that time.



ANORA LIGHTING
Official Web Site

Reading and Writing Table Lamps

Anora Lighting (Foshan) Co.,Ltd.

<https://www.anoralighting.com>

No.18, Xingye 4th Road, Chencun Town, Foshan City, Guangdong, CHINA

Contact: Nova

E-mail: nova@anoralighting.com, WhatsApp: +8618024165146

Contact: Rita

E-mail: rita@anoralighting.com, WhatsApp: +8618024169261